

PRODUCT SHEET

Description:

64mm Dowel Fuerte, \varnothing 11mm x 52mm + M8 x 12mm, Steel BZP

Item number:

11.03.620-4

Units	Box	Carton	HS Code	Barcode
Pcs.	1	400	7318190090	
				5704866012553

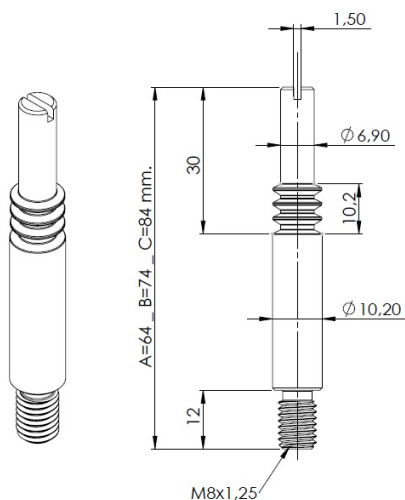

A	11.03.620-4
B	11.03.621-2
C	11.03.625-3

SISO A/S

Mileparken 11
DK-2740 Skovlunde
Denmark
VAT: DK 24786013

Phone +45 45 830 900

www.siso.dk
siso@siso.dk

Danske Bank
Nytorv Branch
Copenhagen
SWIFT: DABADKKK

Account no.
4180 3112 112936
IBAN Account
DK7230003112112936